

EUREKA

Cordless, Rechargeable VACUUM CLEANER

Household Type

Owner's Guide Model 96B

Charge 14-16 hours
before first use.

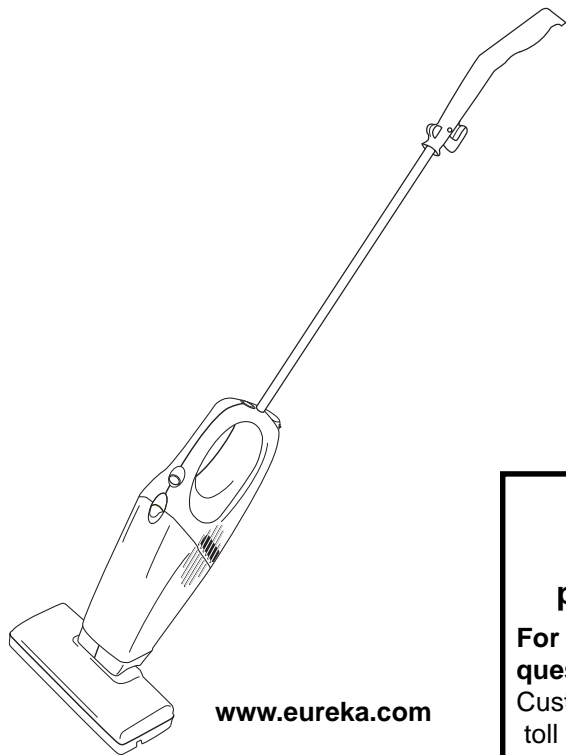

www.eureka.com

Index

Important Safeguards	2
Service Information	4
Assembly	5
Use	7
Dust Cup	7
Filter	8
Battery Disposal	8
Customer Order Form	9
Warranty	11-12

IMPORTANT

Do not return this
product to the store.

**For assembly problems or
questions contact:** Eureka's
Customer Service Division
toll free at 1-800-282-2886*, 7
a.m. to 8 p.m., Central Standard
Time, Monday through Saturday.

**For replacement of broken or
missing items** to be shipped
direct to you, call 1-800-438-
7352*, 8 a.m. to 4:45 p.m.,
Central Standard Time, Monday
through Friday.

***En Mexico llame al 5670-6169.**

IMPORTANT SAFEGUARDS

When using an electric appliance, basic precautions should always be followed, including the following:

Read all instructions before using this vacuum cleaner.

WARNING

To reduce the risk of fire, electric shock, or injury:

- **Do not use outdoors or on wet surfaces.**
- Do not operate the vacuum cleaner or charger that has been damaged in any way. If vacuum cleaner is not working as it should, has been dropped, damaged, left outdoors, or dropped into water, return it to a service center.
- To avoid excessive heat and damage to the unit or batteries, do not operate the vacuum cleaner while in the charging stand.
- Do not allow to be used as a toy. Close attention is necessary when used by or near children.
- Use only as described in this manual.
- Use only the charger provided to recharge; Eureka model 351U-1025-1A for 120 volt.
- Do not pull or carry the charger by cord, use cord as a handle, close a door on cord, or pull cord around sharp edges or corners. Keep cord away from heated surfaces.
- Do not use extension cords or outlets with inadequate current carrying capacity.
- Do not unplug by pulling on cord. To unplug, grasp the charger, not the cord.
- Do not handle charger or vacuum cleaner with wet hands.
- **DO NOT MUTILATE OR INCINERATE BATTERIES AS THEY WILL EXPLODE AT HIGH TEMPERATURES.**
- Leaks from battery cells can occur under extreme usage or temperature conditions. If the liquid gets on the skin (1) wash quickly with soap and water or (2) neutralize with a mild acid such as lemon juice or vinegar. If the liquid gets into the eyes, flush them immediately with clean water for a minimum of 10 minutes. Seek medical attention.
- The terminal on the vacuum cleaner should be kept free and clean of objects. While there is no shock hazard from the terminal, a burn could occur if metal objects are inserted into the terminal area.
- This vacuum cleaner creates suction. Keep hair, loose clothing, fingers, and all parts of body away from openings and moving parts.
- Do not pick up anything that is burning or smoking, such as cigarettes, matches, or hot ashes.
- Do not use without a filter in place. When servicing the unit, never put fingers or other objects into the fan chamber in case the unit would accidentally be turned on.
- Use extra care when cleaning on stairs.
- Do not use to pick up flammable or combustible liquids such as gasoline, or use in areas where they may be present.
- Locate the wall bracket and charger indoors in a cool, dry area not exposed to the weather to avoid electrical shock and/or cleaner damage.
- Keep your work area well lighted.
- Unplug electrical appliances before vacuuming them.

SAVE THESE INSTRUCTIONS

CONSEILS DE SÉCURITÉ

Lors de l'utilisation d'un appareil électrique, quelques précautions élémentaires doivent être observées, incluant les suivantes:

LISEZ TOUTES LES INSTRUCTIONS AVANT D'UTILISER VOTRE ASPIRATEUR.

AVERTISSEMENT

Pour réduire le risque de feu, de choc électrique ou de blessure:

- **N'utilisez pas l'aspirateur à l'extérieur ou sur une surface mouillée.**
- N'utilisez jamais l'aspirateur ou le chargeur s'ils ont été endommagés. Si l'aspirateur ne fonctionne pas comme il le faut, s'il a été échappé, s'il a été endommagé, s'il a été laissé à l'extérieur, s'il a été échappé dans de l'eau, retournez-le à un centre de service avant de l'utiliser.
- Pour éviter que l'aspirateur surchauffe, ou que l'aspirateur ou les piles soient endommagés, n'utilisez pas l'aspirateur lorsqu'il est encore dans son support de recharge.
- Ne permettez pas que l'aspirateur soit utilisé comme un jouet. Une attention particulière est nécessaire lorsqu'il est utilisé par ou près d'un enfant.
- Suivez les recommandations d'utilisation de ce manuel.
- Pour recharger l'aspirateur, utilisez uniquement le chargeur qui l'accompagne – Eureka modèle n° 351U-1025-1A pour 120 volt.
- Ne pas tirer l'aspirateur ou le transporter par le cordon. Ne pas utiliser le cordon en guise de poignée. Ne pas fermer une porte sur le cordon ou tirer le cordon sur des bordures ou des coins pointus. Tenir le cordon à distance des surfaces chauffantes.
- Ne pas utiliser des rallonges ou des prises qui n'ont pas une capacité suffisante pour transporter le courant.
- Ne pas débrancher en tirant sur le cordon. Pour débrancher, empoignez le chargeur et non pas le cordon.
- Ne pas manipuler le chargeur ou l'aspirateur avec les mains mouillées.
- **NE PAS MUTILER OU INCINERER LES PILES. LES PILES EXPLOSENT A DES TEMPERATURES EXCESSIVES.**
- Il peut y avoir des fuites des éléments des piles lorsque celles-ci sont soumises à des conditions d'emploi excessif ou de température excessive. Si le liquide touche la peau (1) laver tout de suite la peau avec de l'eau et du savon (2) Neutraliser avec un acide doux, tel que le jus de citron ou le vinaigre. Au cas de contact avec les yeux, nettoyer à grande eau pour un minimum de 10 minutes. Cherchez des soins médicaux.
- La borne de l'aspirateur doit être maintenue propre et libre de tout autre objet. Il n'y a aucun risque de choc électrique de la borne elle-même, mais une brûlure est possible si des objets en métal sont introduits dans la borne.
- Cet aspirateur crée de la succion. Tenir les parties mobiles et les ouvertures loin des cheveux, des habits, des doigts et de toute partie du corps.
- Ne pas ramasser des objets qui brûlent ou fument comme des cigarettes, des allumettes ou les cendres chaudes.
- Ne pas utiliser sans que le filtre ne soit installé. Lors de réparations ou d'entretien, il ne faut jamais mettre les doigts, ou autres objets, près du ventilateur dans le cas où l'aspirateur serait accidentellement mis en marche.
- Portez une attention particulière lorsque vous nettoyez les escaliers.
- Ne pas utiliser pour ramasser des liquides inflammables ou combustibles comme de l'essence. Ne pas utiliser dans les endroits où ces liquides pourraient être présents.
- Situez le support pour l'aspirateur à l'intérieur, dans un endroit frais, sec et protégé pour éviter le choc électrique ou les dommages.
- Travaillez toujours dans un endroit bien éclairé.
- Débranchez les appareils électriques avant de les nettoyer avec l'aspirateur.

CONSERVEZ CES INSTRUCTIONS

GENERAL INFORMATION

The cordless vacuum cleaner is the answer for quick, convenient, and easy cleanups. Grab the cleaner for little tasks rather than using a larger cleaner. Place the wall bracket in any area of easy access that allows versatile cleaning of kitchen crumbs, or steps. Always store the cleaner in the wall bracket to provide a ready charge.

**Charge for 14-16 hours before first use.
Batteries could lose charge in shipping.**

It is best to charge the batteries when temperatures are between 32°F (0°C) and 104°F (40°C). Other temperatures could damage batteries.

While charging, the charger may become warm to the touch. This is a normal condition and does not indicate a problem.

Service Information

The instructions in this booklet serve as a guide to routine maintenance. If additional service is required, telephone toll free:

USA: 1-800-282-2886
Mexico: 5670-6169
Canada: 1-800-282-2886

for the nearest Eureka Authorized Warranty Station. If you prefer, you can write to The Eureka Company, 807 North Main Street, Bloomington, IL 61701, USA. In Canada write to The Eureka Company, 866 Langs Drive, Cambridge, Ontario N3H 2N7. Refer to The Eureka Warranty for complete service information.



DO NOT OIL. The motor has lubrication and has a permanent seal.

Rating Plate

The model number is indicated on the rating plate which is located on the underside of the vacuum cleaner. For prompt and complete service, always refer to these numbers

Model and Type No. _____

Serial No. or Date Code _____

THE EUREKA COMPANY

Bloomington, Illinois 61701 USA
HOUSEHOLD TYPE

MODEL

Important Battery Disposal Information - Call 1-800-822-8837

Nickel-Cadmium Batteries

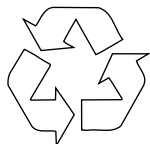

Ni-Cd

Your vacuum cleaner uses nickel-cadmium batteries in a removable pack. To protect our environment, properly dispose of the battery pack when the batteries no longer hold a charge. A municipal waste will not dispose of the battery pack.

Remove the battery pack and take or send it to your nearest Eureka Warranty Service Station. **To learn the address of the nearest factory service center call 1-800-282-2886.**

NOTE: Remove the battery pack only when the batteries no longer hold a charge and you plan to dispose of them.

Identify Parts

NOTE: The charger and the wall bracket are in the packing material of the shipping carton.

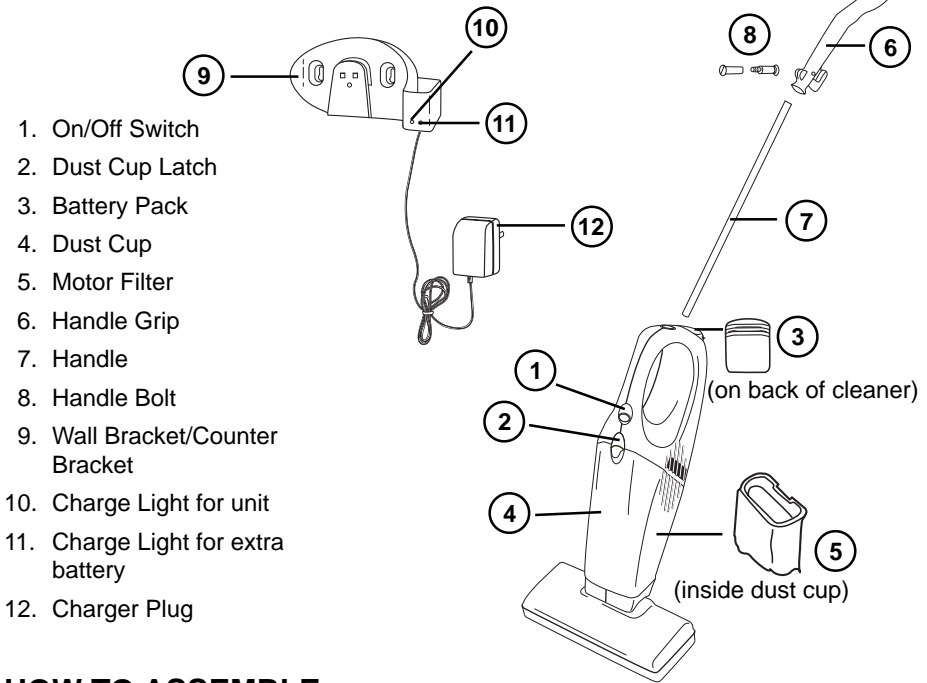

HOW TO ASSEMBLE

Assemble completely and charge batteries for 14-16 hours before using.

Caution: Use only Eureka charger model 351-U-1025-1A

Attach Handle Grip

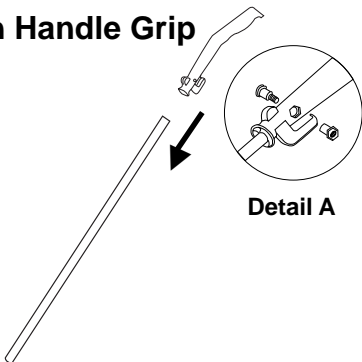

1. Locate the 2-part bolt in the assembly package.
2. Align the hole and secure with the 2-part bolt, see Detail A. Tighten the screws.

Attach Handle

1. Use your thumb to pull back on the lock button.
2. Push handle into top of cleaner.
3. Release lock button and rotate handle until it locks into place.

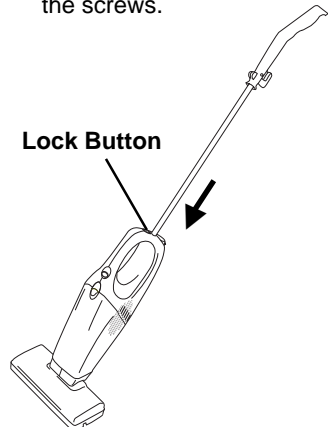

HOW TO ASSEMBLE (continued)

Secure Wall Bracket on Wall

Cleaner hangs in bracket with the nozzle end down. Mount on a wall where there are no dangerous objects hidden beneath the wall surface like electrical wires, pipes, etc. Leave 14 inches above the floor for clearance.

1. Hold bracket against wall to mark location for screws. Make sure the wall bracket is positioned vertically, with the charger socket at the bottom. See Fig. 1.
2. Use a 1/4 inch drill for drilling holes for the plastic anchors.
3. Insert the anchors and drive the screws into both holes.
4. Tighten the screws to secure the bracket.
5. Place cleaner, with the nozzle pointed down, on the wall bracket, Fig. 1.
6. Plug the charger into an electrical outlet.

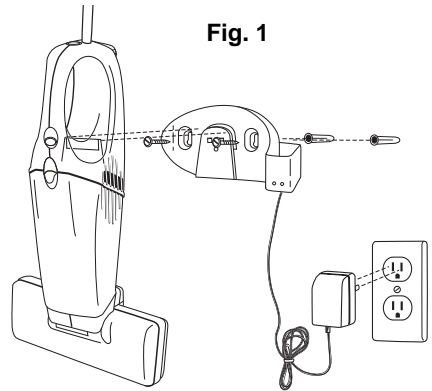
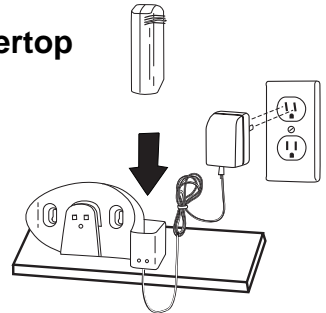

Fig. 1

How to Use Charger on Shelf or Countertop

This charger has been designed to use as either a wall mounted charger or to sit on a counter or shelf. To use on a counter or shelf, locate next to an electrical outlet. Take the battery out of the cleaner and put in the charger stand as shown to the right. The charge light will indicate that the battery is charging.



Charge the Batteries

NOTE: Charge the batteries for 14-16 hours before initial use. A cleaner may lose charge in shipment. The plug charger will become warm, however, this is not a cause for concern.

NOTE: If the batteries are completely void of charge, the charging light may not shine until there is sufficient charge in the batteries to provide power.

1. Turn the nozzle down and lower the cleaner onto the bracket.
2. When the charge light lights up it indicates that the battery in the unit and/or an extra battery is charging.

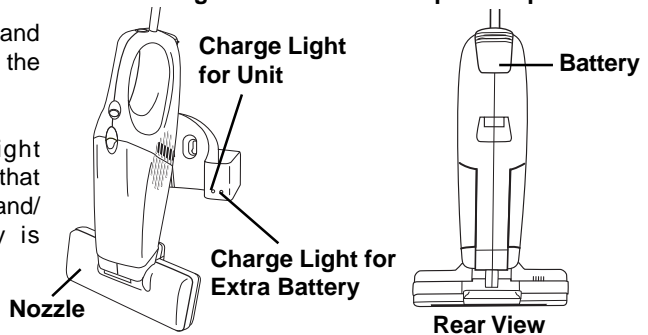

It is all right to leave the cleaner on constant charge so it is always ready to use. Unplug only if it will not be in use for several weeks at a time.

NOTE: You can charge a battery in the unit and an extra battery (optional) at the same time.

HOW TO USE

Power Switch

1. Push the power switch down to turn on; push up to turn off.
2. Select type of cleaning. Carpet cleaning starts the brush roll turning. Bare floor cleaning stops the brush roll.

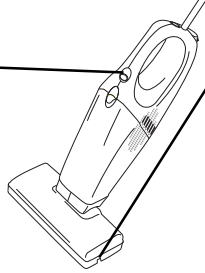
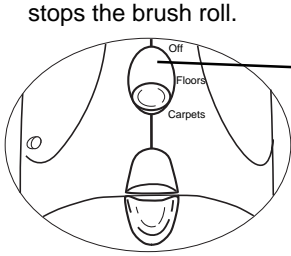

Nozzle with Edge Kleener®

The nozzle turns down for regular or low profile cleaning. Airflow under the nozzle automatically directs suction to the edges and corners for maximum full width cleaning.

Dual Uses

To operate as a handvac remove the handle by releasing the lock button.

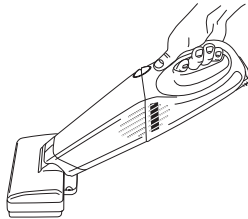

To operate as a stick vac attach the handle.

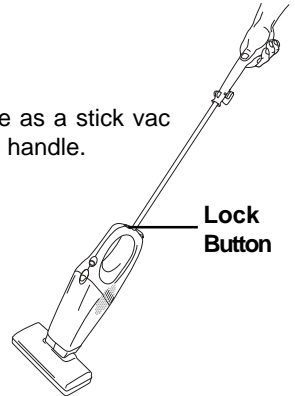

HOW TO MAINTAIN

The instructions given in this booklet serve as a guide to routine maintenance. Keep the cleaner operating at top efficiency. Empty the dust cup after each use.

Empty Dust Cup

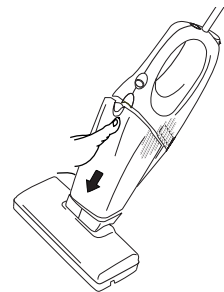
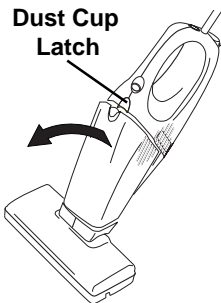

1. Slide dust cup latch up.
2. Pull dust cup from handle section and lift from the nozzle.
3. Pull the filter out of the dust cup, shake contents of dust cup into a waste container. (To clean dust cup filter refer to dust cup filter section.)
4. To replace dust cup, fit dust cup down into nozzle.
5. Gently squeeze the sections together until the dust cup latch locks the cup in place.

Clean Dust Cup Filter

Clean the dust cup filter as necessary.

1. Remove dust cup.
2. Pull dust cup filter out of dust cup.
3. Shake and brush the dust and dirt from filter.
4. If desired, launder the filter by hand in warm water using a mild detergent.

NOTE: The dust cup filter is not dishwasher safe. Do not put in dishwasher.

5. Air dry thoroughly.
6. Replace filter in dust cup by pushing the seal located at the top in firmly to ensure proper filter performance.

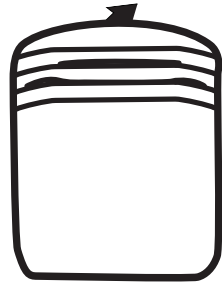

Replace a dirty or torn filter. Order additional dust cup filters from The Eureka Company, Bloomington, IL 61701. Order dust cup filter, part number 61544.

Battery Disposal - For information 1-800-822-8837

NOTE: Dispose of the battery when it no longer holds a charge.

CAUTION: Do not short circuit or dispose of in fire. Dispose of properly.

A municipal waste will not dispose of the battery. Use a recycling center if one is convenient. Otherwise, take or send the battery to your nearest Eureka Warranty Service Station. To learn the address of the nearest factory service center call 1-800-282-2886.

1. Push up on finger grips on the back of disposable battery.
2. Pull up and out to remove.
3. Hold replacement battery so finger grips on the back of the battery are facing outward.
4. Push the battery down into the cleaner until it snaps securely into place.

CAUTION: To avoid risk of fire, use Eureka battery, part number 60776.

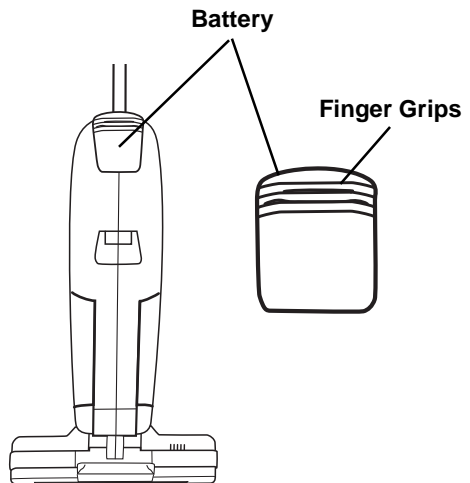

ORDER FORM

(Not applicable in Canada)

S O L D T O

Name _____

Address (street address needed for UPS) _____

City _____ State _____ Zip _____

Telephone (Day) _____ (Eve) _____ (Fax) _____

S H I P T O

Name _____

Address (street address needed for UPS) _____

City _____ State _____ Zip _____

Telephone (Day) _____ (Eve) _____ (Fax) _____

To Order



By Phone

1-800-438-7352*

Call between 8 a.m. and 4:45 p.m. central standard time Monday through Friday.

By FAX

1-309-823-5789

*En Mexico
 Llama al 5670-6169

By Mail



Simply fill out this Order Form. Please be sure to include day and evening phone numbers.

www.eureka.com

59814

Genuine Eureka Parts			
Model Number	Type	Serial Number	Part No. Qty. Price (USD) Total
	Filter (96B, 162, 169)		61544 3.99
	Filter (96A, 164, 168)		60777 2.79
	Charging Stand w/Charger (96 only)		60778 14.29
	Battery Pack (96 only)		60776 16.79
			Total (prices subject to change without notice)
			Tax (add state and local taxes as required by law)
			Postage and Handling Charge (Within the U.S.A.) \$3.75
			TOTAL

To Answer Problems or Questions for U.S.A. and Canada call:

1-800-282-2886*

7 a.m. to 8 p.m. central standard time Monday through Saturday

Method of Payment (No C.O.D.s)

- Check or money order (payable to The Eureka Company). Do not send currency.
- Charge to my Visa (13/16 digits) MasterCard (13 digits) American Express (15 digits)

Acct. number _____

Expiration date _____

Signature (Full name as shown on account) _____

THE EUREKA LIMITED WARRANTY

What This Warranty Covers

Your Eureka cleaner is warranted to be free from all defects in material and workmanship in normal household use for a period of one year. The warranty is granted only to the original purchaser and members of his or her immediate household. The warranty is subject to the following provisions.

What This Warranty Does Not Cover

- Parts of the cleaner that require replacement under normal use, such as disposable dust bags, filters, drive belts, light bulbs, and brush roll bristles
- Damages or malfunctions caused by negligence, abuse, or use not in accordance with the Owner's Guide.
- Defects or damages caused by unauthorized service or the use of other than Genuine Eureka parts.

What The Eureka Company Will Do

The Eureka Company will, at its option, repair or replace a defective cleaner or cleaner part that is covered by this warranty. As a matter of warranty policy, the Eureka Company will not refund the consumer's purchase price.

Warranty Registration

Please fill out and return the warranty registration card accompanying your cleaner.

Obtaining Warranty Service

To obtain warranty service you must return the defective cleaner or cleaner part along with proof of purchase to any Eureka Authorized Warranty Station.

You will find the nearest location in the Yellow Pages, under "Vacuum Cleaners—Service and Repair." Be certain that the Warranty Station is "Eureka Authorized."

For the location of the nearest Eureka Authorized Warranty Station or for service information, telephone toll free:

USA: 1-800-282-2886

Mexico: 5670-6169

Canada: 1-800-282-2886

If you prefer, you can write to The Eureka Company, Service Division, 807 North Main Street, Bloomington, Illinois 61701, USA. In Canada write to The Eureka Company, 866 Langs Drive, Cambridge Ontario N3H 2N7.

If it is necessary to ship the cleaner outside your community to obtain warranty repair, you must pay the shipping charges to the Eureka Authorized Warranty Station.

Return shipping charges will be paid by the Warranty Station. When returning parts for repair, please include the model, type, and serial number from the data plate on the cleaner.

Further Limitations and Exclusions

Any warranty that may be implied in connection with your purchase or use of the cleaner, including any warranty of Merchantability or any warranty for Fitness For A Particular Purpose is limited to the duration of this warranty. Some states do not allow limitations on how long an implied warranty lasts, so the above limitations may not apply to you.

Your relief for the breach of this warranty is limited to the relief expressly provided above. In no event shall Eureka be liable for any consequential or incidental damages you may incur in connection with your purchase or use of the cleaner. Some states do not allow the exclusion or limitation of incidental or consequential damages, so the above limitation or exclusion may not apply to you.

This warranty gives you specific legal rights. You may also have other rights which vary by state.



Questions & Answers about Genuine Eureka Products

- Q: Why should I use only Genuine Eureka paper bags, belts, and parts in my Eureka vacuum cleaner?
A: Using Genuine Eureka Products, which are made to our exacting specifications and engineered with emphasis on quality, performance, and customer satisfaction, ensures the long life and cleaning efficiency of your vacuum cleaner. Overall, this saves you money and helps to keep your home clean.
- Q: How can I be sure I am using only genuine Eureka products in my vacuum cleaner?
A: Typically, packaged products and paper bags can be identified by a "Genuine Eureka Product" symbol (see illustration above). For further identification assistance, you may call our toll-free number, 1-800-282-2886, for the location of a nearby Eureka Authorized Warranty Station.
- Q: Are there any differences between "made to fit" or "imitation" and Genuine Eureka paper bags, belts, and parts?
A: Yes, there are some very important differences in materials, quality, and reliability. Many customers have mistakenly purchased "imitation" paper bags and parts while thinking they purchased genuine. Unfortunately, many of these customers discovered the differences after they experienced related difficulties.

For Genuine Eureka Value, Accept No Imitations!

THE EUREKA COMPANY

Bloomington, Illinois 61701

